

DIFFERENT INSTALLATION FORMATS FOR GARBY - DIMBLER - GARBY COLONIAL COLLECTIONS

ICONIC SWITCHES & SOCKETS SINCE 1950

Our offer is a commitment to authenticity: porcelain, brass and wood in their purest state. Local and 100% handmade manufacturing with limited production and more than 70 years of experience, giving rise to 4 differentiating concepts:

TIMELESS AESTHETICS

It can be integrated with the latest design trends.

ADAPTATION CAPACITY

Suitable for both houses in the country and urban areas. It recreates the charm of other times with an impeccable finish.

EXCLUSIVE FINISHES

Perfect combinations of exquisite materials such as the porcelain of the cases contrasting with brass or natural woods from sustainable forests.

VERSATILE INSTALLATIONS

The Fontini collections maintain their decorative spirit, whatever your needs may be. Surface and flush-mounting installation, on bases, with tube, ...

Types of installation

SURFACE

I GARBY

The surface installation revolution. Garby has no technical limits and adds the final touch of order to indoor spaces.



I DIMBLER

Dimbler brings us back to a time when switches were beginning to offer beauty but with a quality of materials that was impossible in the past.



FLUSH-MOUNTING

I GARBY COLONIAL

This maintains the same iconic characteristics as the Garby collection. Garby Colonial adds elegance and practicality for installation on universal flush-mounting boxes.



5 DIFFERENT INSTALLATION SOLUTIONS

A.- Surface installation with cable visible or in metallic tube.

1

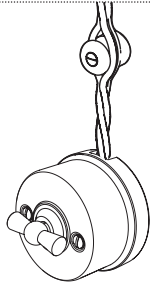

Use the versions with cable-inlet from Garby or Dimbler.



2

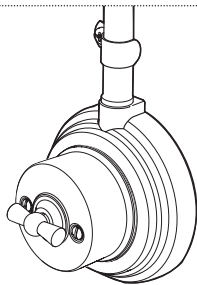

Use the versions with or without cable-inlet from Garby or Dimbler and Garby bases.



B.- Surface installation on Garby-specific flush-mounting box.

3

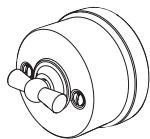

Use the versions without cable-inlet from Garby or Dimbler.



C.- Surface installation on universal flush-mounting box.

4

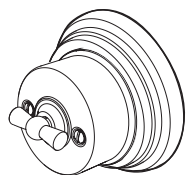

Use the versions without cable-inlet from Garby or Dimbler.



5

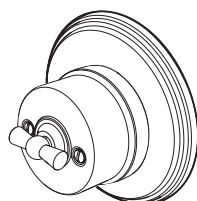

Use the versions without cable-inlet from Garby or Dimbler and Garby frames.



A.1

GARBY OR DIMBLER

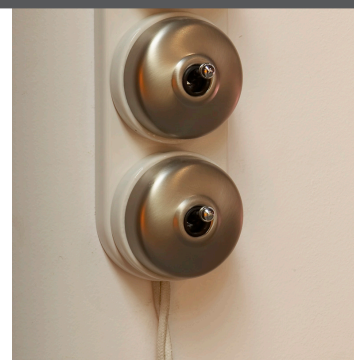
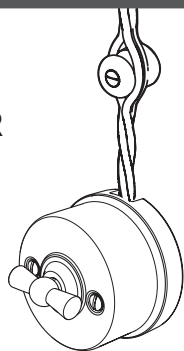

SURFACE INSTALLATION WITH VISIBLE CABLE

The perfect solution for rural homes where you want to recreate the style of the facilities of other times combined with current technological solutions.

NOTE: It is necessary to use Garby or Dimbler mechanisms with cable-inlet.



The installation can be carried out in 3 different ways:

1. Using only the Garby or Dimbler mechanism.
2. Combined with Garby surface bases.
3. Combined with Garby Colonial frames.

DIRECT MOUNTING

No additional accessories are required for mounting.

INSTALLATION WITH BASE

Porcelain and wooden frames with 1, 2 or 3 elements for horizontal or vertical installation.

If you want to use Dimbler in combination with Garby bases, it is necessary to use the height supplement. (Ref. 60952032)

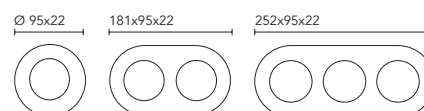

INSTALLATION WITH GARBY COLONIAL FRAME

Garby beech wood bases with 1, 2 or 3 elements for horizontal or vertical installation.

If you want to use Dimbler in combination with Garby bases, it is necessary to use the height supplement. (Ref. 30950982)

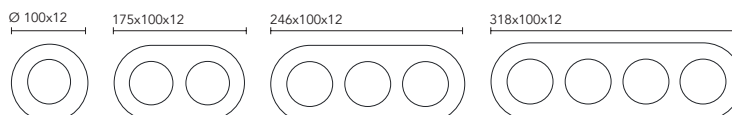

IMPORTANT: According to the current Low Voltage Electrotechnical Regulations in Spain, the 750V PVC braided wire is only suitable for refurbishing works or modifications of existing installations that do not affect more than 50% of the installed power.

It is advisable to install insulators 40 cm apart. (Ref. 30913...)



A.2

GARBY OR DIMBLER

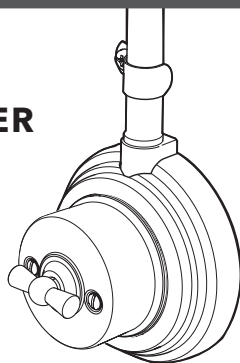

SURFACE INSTALLATION WITH METALLIC TUBE

When an electrical installation acquires prominence as a decorative element. Installation with visible metallic tube Ø16, 20 or 25 mm.

NOTE: Both types of mechanisms, with or without cable-inlet, can be used.



Garby beech wood bases:

1. 1, 2 or 3 element bases with 1 tube inlet.
2. 1, 2 or 3 element bases with 2 tube inlets.
3. Horizontal or vertical installation.

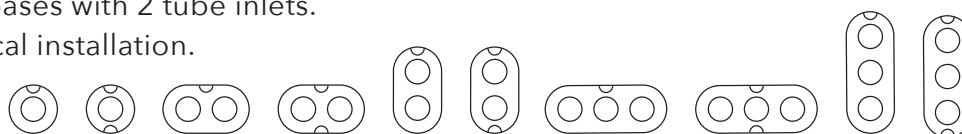

MOUNTING ACCESSORIES

For Garby:

No additional accessories are required for mounting

For Dimbler:

A height supplement for the base is required.

(Ref. 60952032)



INSTALLATION SCHEME

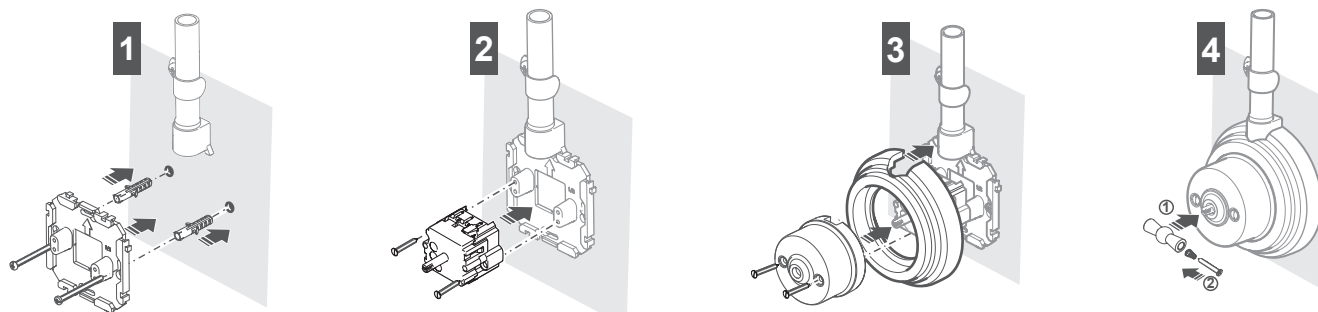

Accessories for installation with visible metallic tube Ø 16, 20 or 25 mm:

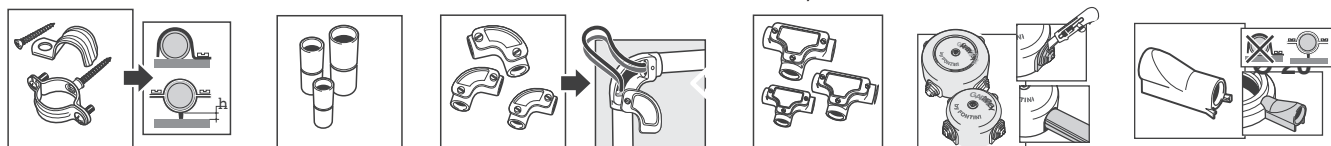

B.3

GARBY OR DIMBLER

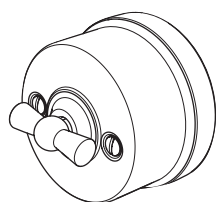

SURFACE INSTALLATION ON GARBY-SPECIFIC FLUSH-MOUNTING BOX

Fontini has created a special flush-mounting box that allows the installation of Garby and Dimbler surface-mounted mechanisms on flush-mounting installations, with no need for additional elements. The purity of the Garby design combined with the practicality of a flush-mounting installation.

NOTE: It is necessary to use Garby or Dimbler mechanisms without cable-inlet.



DESCRIPTION

- Garby-Dimbler special flush-mounting box (Ref.: 30993020)
- The flush-mounting box can be linked to create multiple groups of mechanisms 2 cm apart thanks to the supplied spacer.
- Valid for installation on brick and plasterboard.



- Fixing screws for plasterboard (Ref.: 30995000)
- So the Garby-Dimbler box can be used on plasterboard.



INSTALLATION SCHEME

New installation

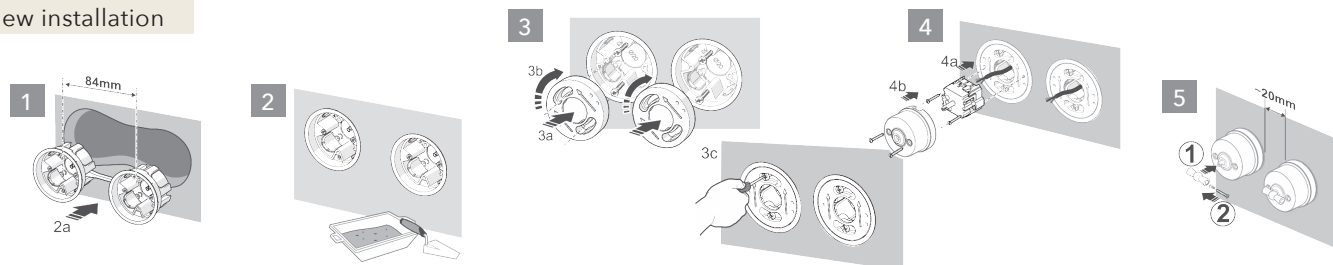

Renovation in existing box



Attach the Garby box inside the existing box.

Install the mechanism and paint.

C.4

GARBY OR DIMBLER

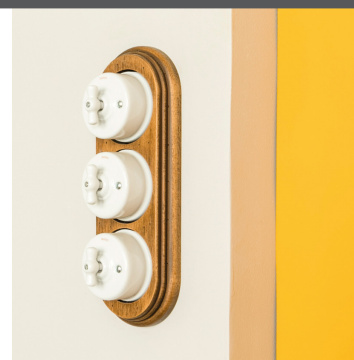
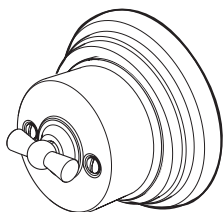

SURFACE INSTALLATION ON UNIVERSAL FLUSH-MOUNTING BOX WITH BASE

Play with materials and finishes by combining Garby and Dimbler with Garby's beech wood bases, allowing a decorative surface style to be maintained using existing universal flush-mounting boxes.

NOTE: It is necessary to use Garby or Dimbler mechanisms without cable-inlet.



Garby beech wood bases:

- 1. 1, 2 or 3 element bases.
- 2. Horizontal or vertical installation.

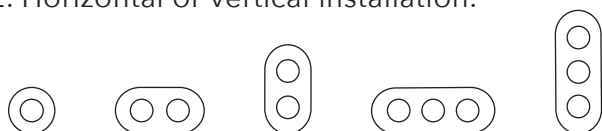

Mounting on universal flush-mounting box with existing screws.



INSTALLATION SCHEME

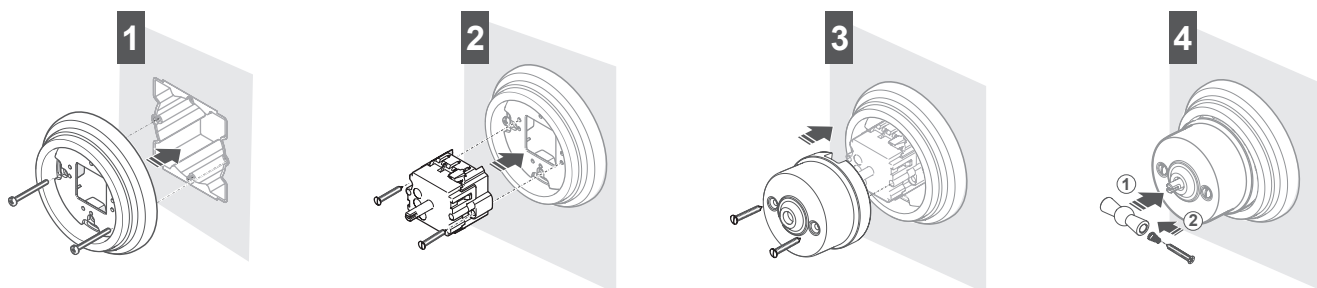
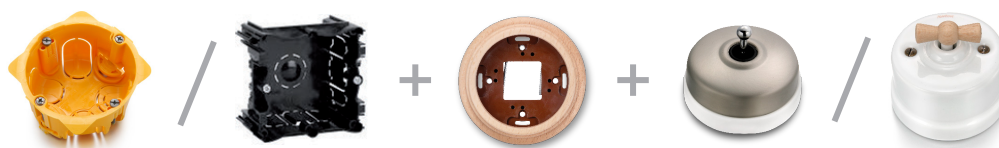

C.5

GARBY OR DIMBLER

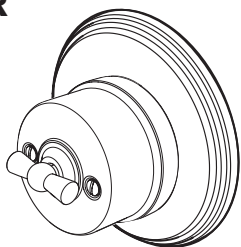

SURFACE INSTALLATION ON UNIVERSAL FLUSH-MOUNTING BOX WITH GARBY COLONIAL FRAMES

Play with materials and finishes by combining Garby or Dimbler with Garby Colonial frames. A decorative surface-mounted style using existing flush-mounting boxes.

NOTE: It is necessary to use Garby or Dimbler mechanisms without cable-inlet.



Porcelain or wooden frames by Garby Colonial

- 1, 2 or 3 element frames.
- Horizontal or vertical installation.

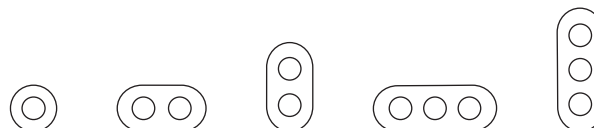

ACCESSORIES REQUIRED FOR MOUNTING

Use adapter for surface-mounted frames with socket plate for flush-mounting installation. (Ref. 30951982)

For mounting on universal flush-mounting box with screws.



INSTALLATION SCHEME

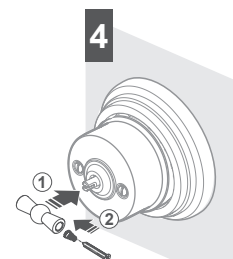
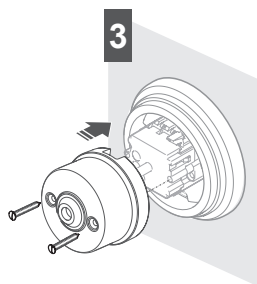
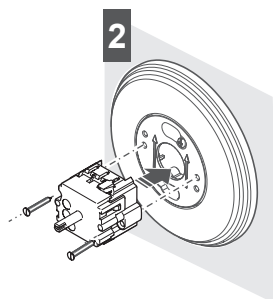
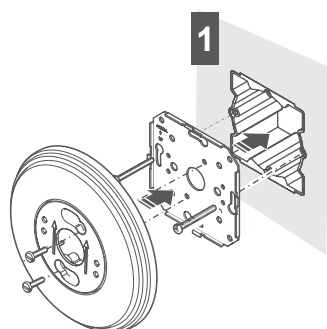
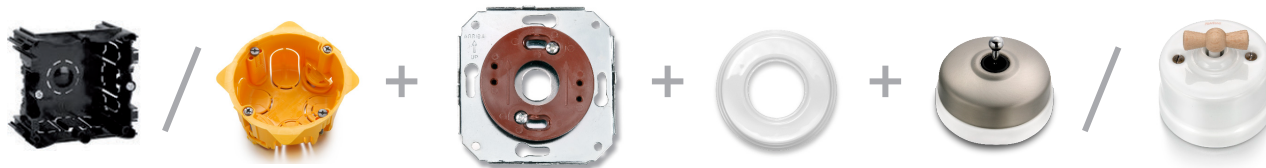

D.6

GARBY COLONIAL

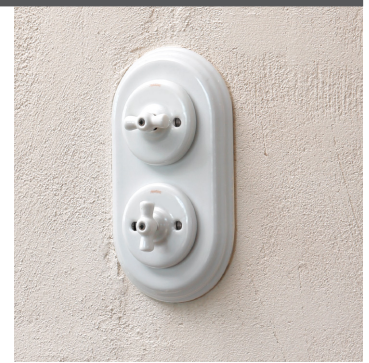

FLUSH-MOUNTING INSTALLATION ON UNIVERSAL FLUSH-MOUNTING BOX

Tradition and craftsmanship combined with efficiency in installation.

Plates made of porcelain or beech wood with 1, 2 or 3 elements.
Horizontal or vertical installation.

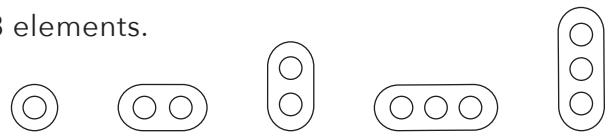

ACCESSORIES REQUIRED FOR MOUNTING

Mounting on universal flush-mounting box with existing screws.

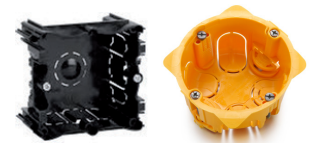

INSTALLATION SCHEME

